

Dell Projectors

User Guide



Notes, cautions, and warnings

 **NOTE:** A NOTE indicates important information that helps you make better use of your product.

 **CAUTION:** A CAUTION indicates either potential damage to hardware or loss of data and tells you how to avoid the problem.

 **WARNING:** A WARNING indicates a potential for property damage, personal injury, or death.

Copyright © 2017 Dell Inc. or its subsidiaries. All rights reserved. Dell, EMC, and other trademarks are trademarks of Dell Inc. or its subsidiaries. Other trademarks may be trademarks of their respective owners.

Contents

1 About Your Dell Projector	5
General Safety Information.....	5
2 Cables and Documentation	6
3 Connecting with VGA and External Speakers	7
4 Connecting a Computer or DVD Player Using an HDMI Cable	8
5 Monitor Loop-Through Connection Using VGA Cables	9
6 Turning Your Projector On	10
7 Turning Your Projector Off	11
8 Raising and Lowering the Projector Height	12
9 Adjusting the Projector Focus	13
10 Adjusting Projection Image Shape	14
11 Input Source	16
12 Auto Adjust	17
13 Brightness/Contrast	18
14 Video Mode	19
15 Audio Volume	20
16 Advanced Settings	21
Image Settings (in PC Mode).....	21
Image Settings (in video mode).....	22
DISPLAY SETTINGS (IN PC MODE).....	22
DISPLAY SETTINGS (IN VIDEO MODE).....	24
PROJECTOR SETTINGS.....	26
Menu Settings.....	27
POWER SETTINGS.....	29
Information.....	30
17 Language	31
18 Help	32



19 Changing the Lamp..... 33

20 Guiding Signals..... 34

21 Dell Web Management for Projectors.....36

22 Getting help.....52

 Contacting Dell.....52

23 Glossary.....53



About Your Dell Projector

General Safety Information

CAUTION: Safety Instructions

- 1 Do not install near heat sources such as radiators, heaters, stoves or any other apparatus, such as amplifiers, that emit heat.
- 2 Do not use the projector in a dusty environment. Excess dust can cause system failures and eventually will shut down your projector.
- 3 Ensure that the projector is mounted in a well-ventilated area.
- 4 Do not block the ventilation slots and openings on the projector.
- 5 Ensure that the projector operates between ambient temperatures of (5 °C to 40 °C).
- 6 Do not touch the ventilation outlet as it will become heated during operation or immediately after the projector is turned off.
- 7 Do not look into the lens while the projector is on as it may cause injury to your eyes.
- 8 Do not place any objects near or in front of the projector or cover its lens while the projector is on as the heat may cause the object to melt or burn.
- 9 Do not use alcohol to wipe the lens.

NOTE:

- Do not attempt to ceiling mount the projector yourself. It should be installed by a qualified technician.
- Recommended Projector Ceiling Mount Kit (P/N: C3505). For more information, see the Dell Support website at [Dell.com/support](https://www.dell.com/support)
- For more information, see the Safety Information that shipped with your projector.
- With the exception of Dell mobile projectors, most Dell projectors can only be used indoors.

NOTE: Ceiling mount screw hole M3 x 6.5 mm depth.

Recommended torque <15 kgf-cm.



Cables and Documentation

Your Dell Projector ships with the necessary cables and documentation to get you started! Visit www.dell.com/support to explore further support options.



Connecting with VGA and External Speakers

NOTE: The projector shown is for representational purposes only.

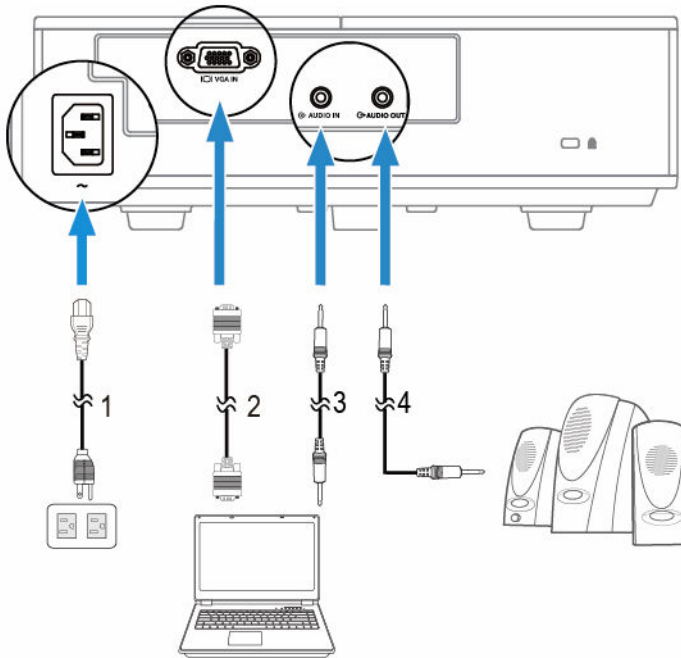

- | | | | |
|---|-----------------------------|---|--------------------------------------|
| 1 | Power cable | 2 | Video Graphics Adapter (VGA) cable |
| 3 | Audio-in cable to projector | 4 | Audio-out cable to external speakers |

Connecting a Computer or DVD Player Using an HDMI Cable

NOTE: The HDMI cable is not shipped with your projector. You can purchase an HDMI cable on the Dell website at

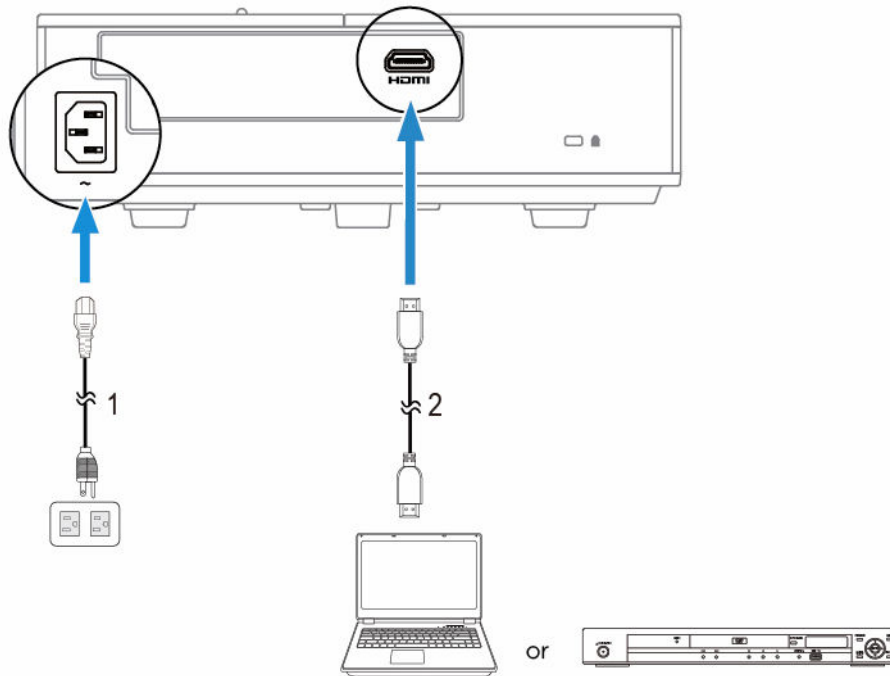

www.dell.com

- 1 Power cable
- 2 HDMI cable

Monitor Loop-Through Connection Using VGA Cables

① **NOTE:** Only one VGA cable is shipped with your projector. Any additional cables can be purchased from www.dell.com

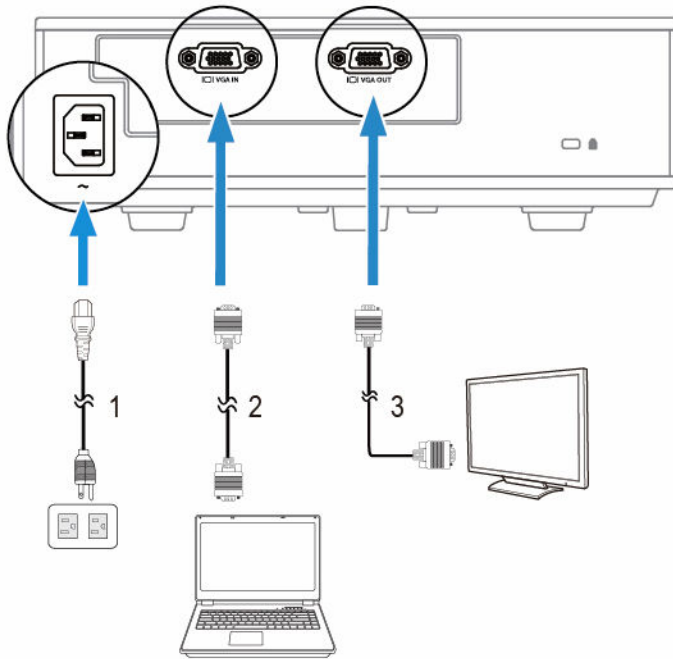

1 Power cable

2 VGA to VGA cable (laptop to projector)

3 VGA to VGA cable (projector to monitor)

Turning Your Projector On

NOTE: Turn on the projector before you turn on the source (computer, DVD player, etc.). The Power button light glows white until pressed.

- 1 Connect the power cord and appropriate signal cables to the projector.
- 2 Press the Power button on the remote control.
- 3 Turn on your source (computer, DVD player, etc.).
- 4 Connect your source to the projector using the appropriate cable.
- 5 By default, the input source of the projector is set to VGA-In. Change the input source of the projector if necessary.
- 6 If you have multiple sources connected to the projector, press the Source button on the remote control to select the desired source.

Turning Your Projector Off

 **CAUTION:** Unplug the projector after properly shutting down as explained in the following procedure.

1 Press the Power button. Follow the instruction displayed on screen to properly turn off the projector.

 **NOTE:** The "Press Power Button to Turn off Projector" message will appear on the screen. The message disappears after 5 seconds or you can press the Menu button to clear it.

2 Press the Power button again. The cooling fans continue to operate for 120 seconds.

3 To power off the projector quickly, press the Power button and hold for 1 second while the projector's cooling fans are still running.

 **NOTE:**
Before you turn on the projector again, wait for 60 seconds to allow the internal temperature to stabilize.

4 Disconnect the power cord from the electrical outlet and the projector.

Raising and Lowering the Projector Height

Raise or lower the projector, and use the front tilt adjustment wheel/push button to fine-tune the display angle.

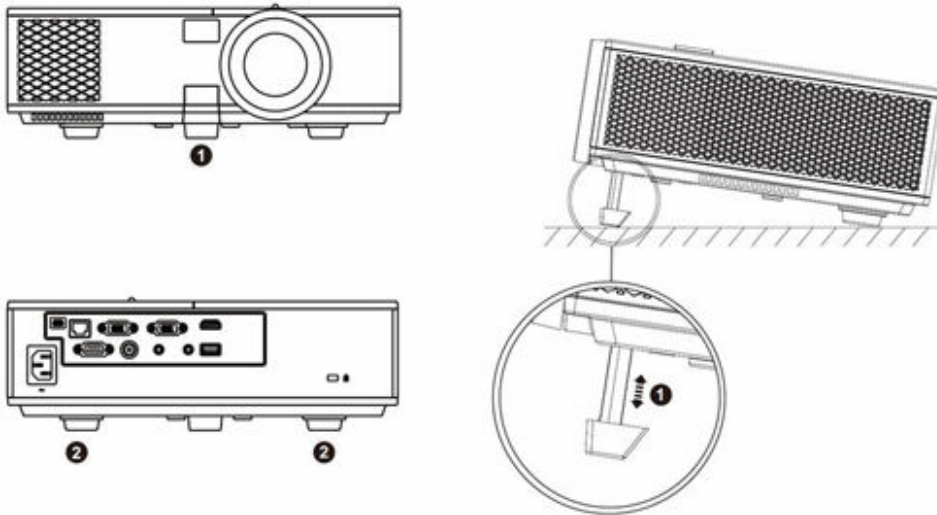

1 Front tilt adjustment wheel/push button (angle of tilt: -5 to 5 degrees)

2 Fixed rubber foot

Adjusting the Projector Focus

Rotate the focus ring (2) until the image is clear. The projector focuses at distances ranging between 3.94 ft - 32.81 ft (1.2 m - 10 m).

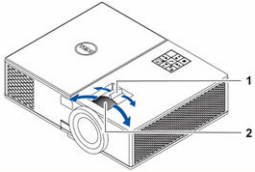

1 Zoom tab

2 Focus ring

Adjusting Projection Image Shape

NOTE: The tables below are for representational purpose only. Please refer to your projector's User Guide for model-specific information.

Table 1.

Min Zoom					
Projection Distance (m)	Diagonal (inch/cm)	Image size		Projector base to top of image (cm)	Projector base to bottom of image (cm)
		Width (cm)	Height (cm)		
[A]	[B]	[W]	[H]	[C]	[D]
1.2	27.4"/69.6 cm	56	42	48	6
3	69"/ 175.26 cm	140	105	120	15
5	114"/ 289.56 cm	233	174	201	27
7	160"/ 406.4 cm	326	244	281	37
9	206"/ 523.24 cm	419	314	361	47
10	229"/ 581.66 cm	465	349	401	52

Table 2.

Max Zoom					
Projection Distance (m)	Diagonal (inch/cm)	Image size		Projector base to top of image (cm)	Projector base to bottom of image (cm)
		Width (cm)	Height (cm)		
[A]	[B]	[W]	[H]	[C]	[D]
1.2	30"/ 76.2 cm	62	46	53	7
3	76"/ 193.04 cm	154	115	133	18
5	126"/ 320.04 cm	256	192	221	29
7	177"/ 449.58 cm	359	269	310	41
9	227"/ 576.58 cm	462	346	398	52
10	252.4"/ 641.1 cm	513	385	442	57

NOTE: This graph is for user reference only.

NOTE: Offset Ratio: 115 +/- 5%

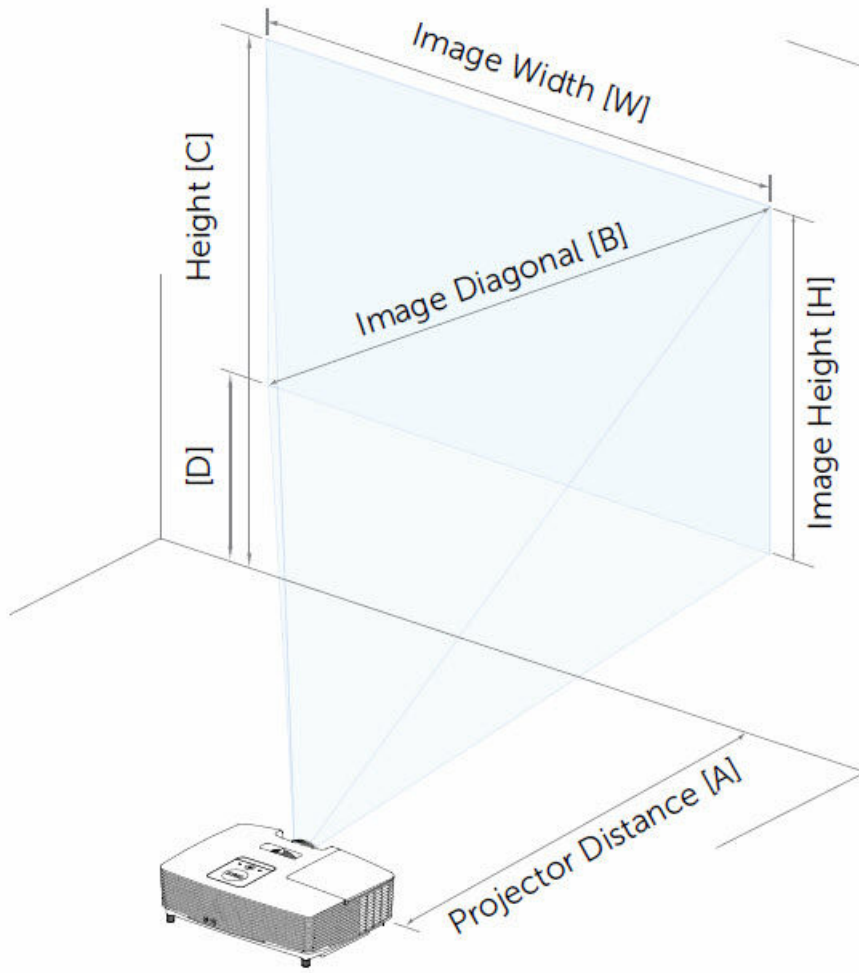

Input Source

The Input Source menu allows you to select your projector's input source.

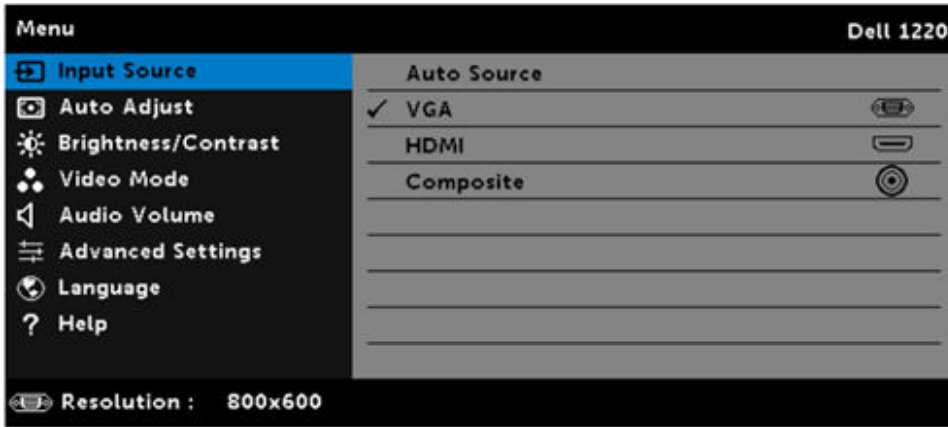

AUTO SOURCE—If you press the  key on the remote control to select, the Auto Source option will automatically find the next available input source.

VGA—Press the  key on the remote control to detect a VGA signal.

HDMI—Press the  key on the remote control to detect a HDMI signal.

COMPOSITE—Press the  key on the remote control to detect a Composite Video signal.

Auto Adjust

Auto Adjust automatically adjusts the projector's Horizontal, Vertical, Frequency, and Tracking in PC mode.

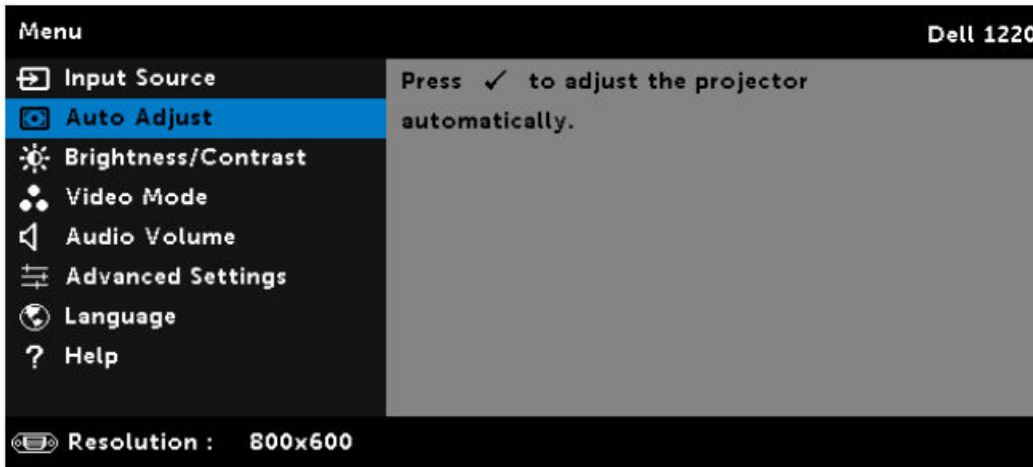

NOTE: Projector model shown is for representational purpose only.

Brightness/Contrast

The Brightness/Contrast menu allows you adjust the brightness/contrast settings of your projector.

BRIGHTNESS—Use the \uparrow and \downarrow keys on your remote control to adjust the brightness of the image.

CONTRAST—Use the \uparrow and \downarrow keys on your remote control to adjust the display contrast.

NOTE: If you adjust the settings for Brightness and Contrast, the projector automatically switches to Custom mode.



NOTE: Projector model shown is for representational purpose only.

Video Mode

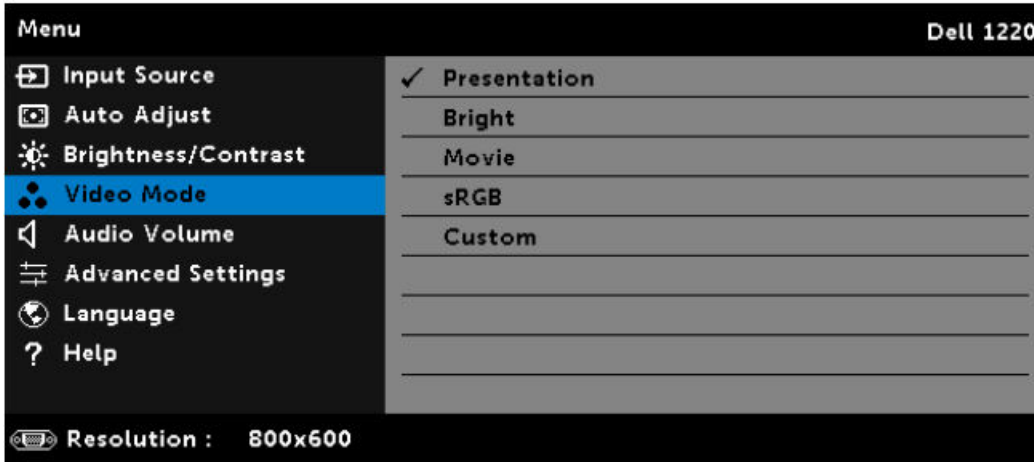

The Video Mode menu allows you to optimize the display image: Presentation, Bright, Movie, sRGB (provides more accurate color representation), and Custom (set your preferred settings).



NOTE: Projector model shown is for representational purpose only.

Audio Volume

The Audio Volume menu allows you to adjust the audio volume settings of your projector.

AUDIO VOLUME—Press the  key on the remote control to increase the audio volume and the  key to decrease the audio volume.

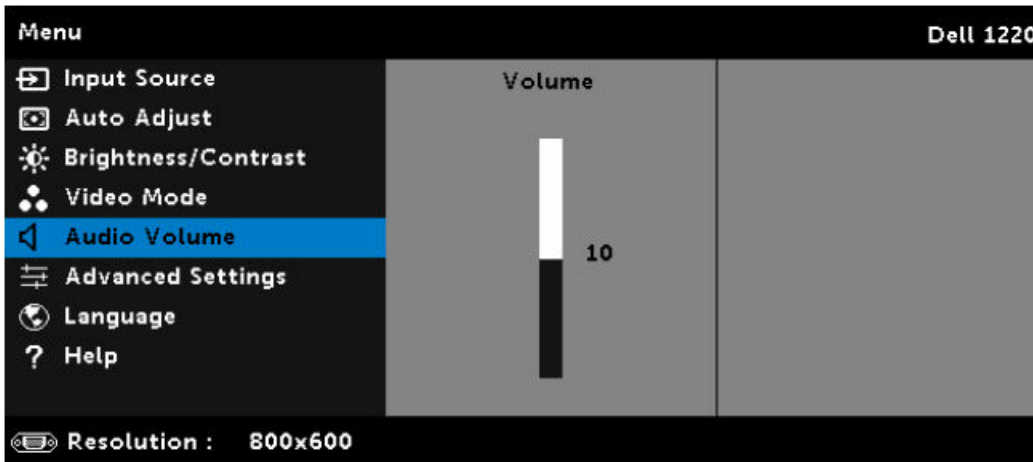

 **NOTE:** Projector model shown is for representational purpose only.

Advanced Settings

The Advanced Settings menu allows you to change the settings for Image, Display, Projector, Menu, Power, and Information.

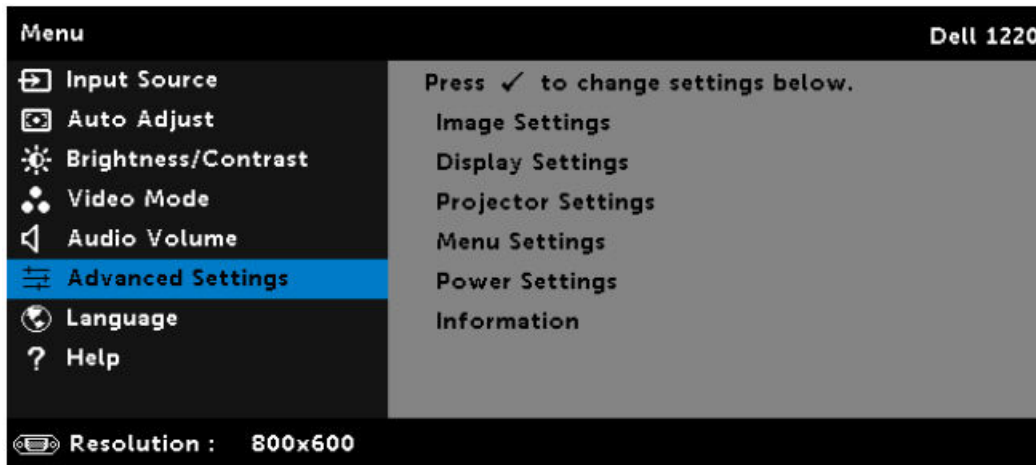

NOTE: The projector model shown is for representational purpose only.

Image Settings (in PC Mode)

Select and press  to activate image settings. The image settings menu provides the following options:

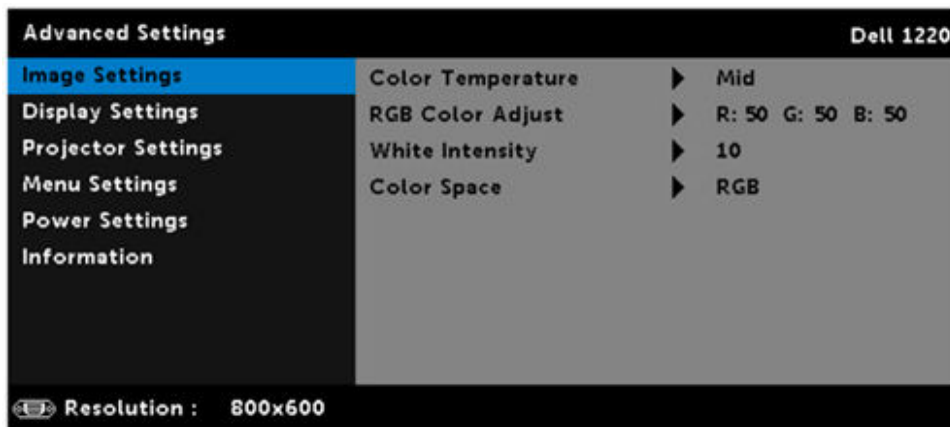

Figure 1.

Color Temperature: Allows you to adjust the color temperature. The screen appears cooler at higher color temperatures and warmer at lower color temperatures. When you adjust the values in the **Color Adjust** menu, the Custom mode is activated. The values are saved in the Custom mode.

RGB Color Adjust: Allows you to manually adjust the colors red, green, and blue.



White Intensity: Press \checkmark and use \uparrow and \downarrow to display white intensity

Color Space: Allows you to select the color space. The options are: RGB, YCbCr, and YPbPr.

NOTE: If you adjust the settings for Color Temperature, RGB Color Adjust, and White Intensity, the projector automatically switches to the Custom mode.

Image Settings (in video mode)

Select and press \checkmark to activate image settings. The image settings menu provides the following options:



Color Temperature: Allows you to adjust the color temperature. The screen appears cooler at higher color temperatures and warmer at lower color temperatures. When you adjust the values in the **Color Adjust** menu, the Custom mode is activated. The values are saved in the Custom mode.

RGB Color Adjust: Allows you to manually adjust the colors red, green, and blue.

Saturation: Allows you to adjust the video source from black and white to fully saturated color. Press \uparrow to increase the amount of color in the image and \downarrow to decrease the amount of color in the image.

Sharpness: Press \uparrow to increase the sharpness and \downarrow to decrease the sharpness.

Tint: Press \uparrow to increase the amount of green in the image and \downarrow to decrease the amount of green in the image.

White Intensity: Press \checkmark and use \uparrow and \downarrow to display white intensity.

Color Space: Allows you to select the color space. The options are: RGB, YCbCr, and YPbPr.

NOTE:

- 1 If you adjust the settings for Color Temperature, RGB Color Adjust, Saturation, Sharpness, Tint, and White Intensity the projector automatically switches to Custom mode.
- 2 Saturation, Sharpness, and Tint only available when the input source is from Composite or S-Video.

DISPLAY SETTINGS (IN PC MODE)

Select and press \checkmark to activate display settings. The display settings menu provides the following options:

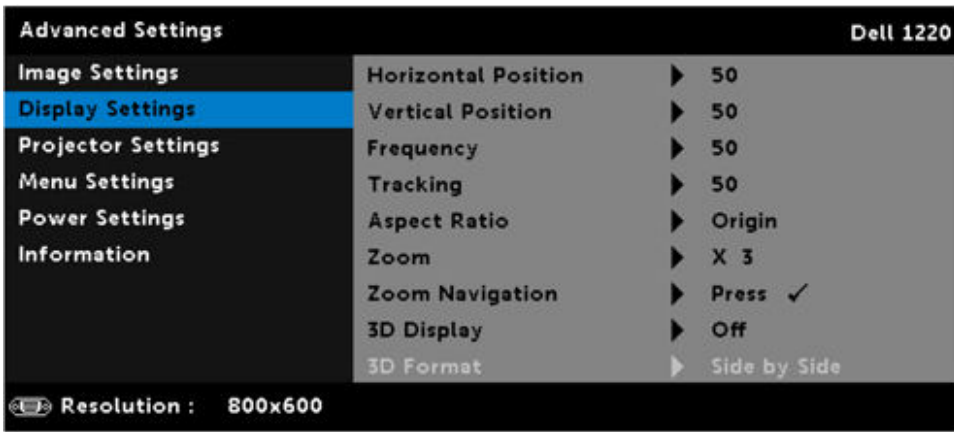

Horizontal Position: Press to move the image right and to move the image left.

Vertical Position: Press to move the image up and to move the image down.

Frequency: Allows you to change the display data clock frequency to match the frequency of your computer's graphics card. If you see a vertical flickering wave, use the Frequency control to minimize the bars. This is a coarse adjustment.

Tracking: Synchronize the phase of the display signal with the graphic card. If you experience an unstable or flickering image, use Tracking to correct it. This is a fine adjustment.

Aspect Ratio: Allows you to select the aspect ratio to adjust how the image appears. Options are: Origin, 16:10, 16:9, and 4:3.

- Origin — Select Origin to maintain the aspect ratio of the image projector according to the input source.
- 16:10 — The input source scales to fit the width of the screen to project a 16:10 screen image.
- 16:9 — The input source scales to fit the width of the screen to project a 16:9 screen image.
- 4:3 — The input source scales to fit the screen and projects a 4:3 image.

Zoom: Press and to zoom and view the image.

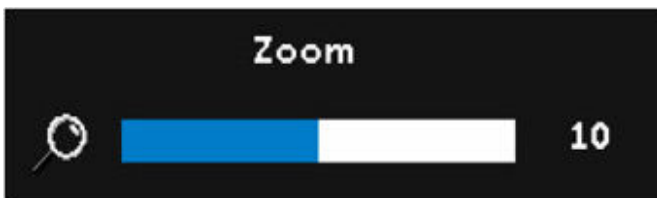

Adjust the image scale by pressing or and press to view on your remote control only.



Press to activate the Zoom Navigation menu. Use to navigate the projection screen.

3D Display: Select On to activate the 3D display function (default is Off).



NOTE: When you want to create a 3D experience, you will need a few other components including:

- Computer/Laptop with a 120 Hz signal output quad-buffered graphics card.
- "Active" 3D glasses with DLP Link™
- 3D content
- 3D player

2. Enable the 3D function when it satisfies any of the below-mentioned conditions:

- Computer/Laptop with graphics card, capable of outputting at 120 Hz signal via VGA cable.
- Input a suite of 3D content via Video.

3. "3D Display" selection will only be enabled in the "Display Settings of the Advanced Settings" menu when the projector detects either of the inputs mentioned above.

4. 3D support and refresh rate are as below:

- VGA/HDMI 1280 x 720, 1024 x 768, and 800 x 600 at 120 Hz
- Composite at 60 Hz

5. The recommended VGA signal for laptops is Single-mode output (Dual mode is not recommended).

6. HDMI 1.4a 3D support rates:

- 1280 x 720p @ 50 Hz Frame Packing
- 1280 x 720p @ 59.94/60 Hz Frame Packing
- 1920 x 1080p @ 23.98/24 Hz Frame Packing
- 1920 x 1080i @ 50 Hz Side by Side Half
- 1280 x 720p @ 50 Hz Top and Bottom
- 1280 x 720p @ 59.94/60 Hz Top and Bottom
- 1920 x 1080p @ 23.98/24 Hz Top and Bottom

3D FORMAT: Allows you to select the 3D format when the 3D display function is activated. Options are: Side By Side, Side By Side Full, Frame Sequential, Field Sequential, Top/Bottom, and Frame Packing.

3D SYNC INVERT: If you see a discrete or overlapping image while wearing DLP 3D goggles, you may need to execute 'Invert' to get best match of left/right image sequence to get the correct image. (For DLP 3D goggles)

DISPLAY SETTINGS (IN VIDEO MODE)

Select and press  to activate display settings. The display settings menu provides the following options:

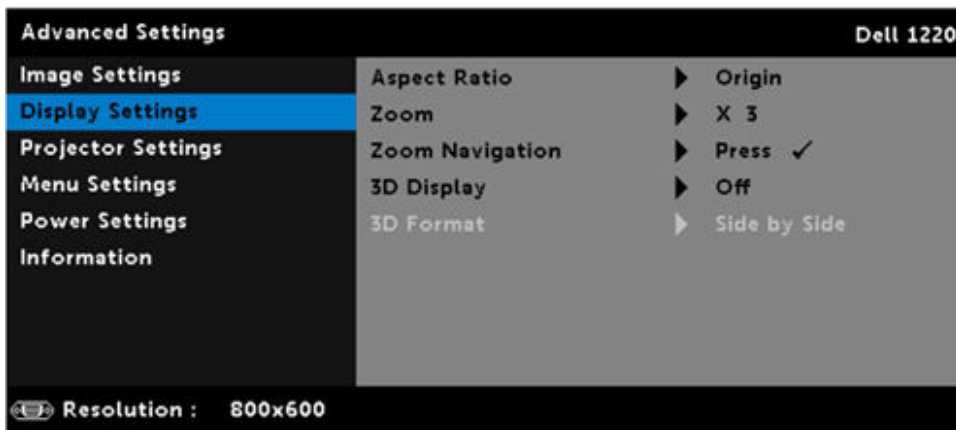



Aspect Ratio: Allows you to select the aspect ratio to adjust how the image appears. Options are: Origin, 16:10, 16:9, and 4:3.



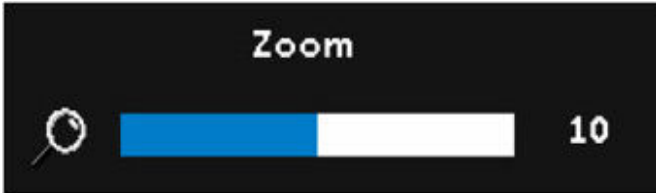

- Origin — Select Origin to maintain the aspect ratio of the image projector according to the input source.
- 16:10 — The input source scales to fit the width of the screen to project a 16:10 screen image.
- 16:9 — The input source scales to fit the width of the screen to project a 16:9 screen image.
- 4:3 — The input source scales to fit the screen and projects a 4:3 image.

Zoom: Press  and  to zoom and view the image.



Adjust the image scale by pressing  or  and press  to view on your remote control only.



Press  to activate the Zoom Navigation menu. Use , , , and  to navigate the projection screen.

3D Display: Select On to activate the 3D display function (default is Off).

NOTE: When you want to create a 3D experience, you will need a few other components including:

- Computer/Laptop with a 120 Hz signal output quad-buffered graphics card.
- "Active" 3D glasses with DLP Link™
- 3D content
- 3D player

2. Enable the 3D function when it satisfies any of the below-mentioned conditions:

- Computer/Laptop with graphics card, capable of outputting at 120 Hz signal via VGA cable.
- Input a suite of 3D content via Video.

3. "3D Display" selection will only be enabled in the "Display Settings of the Advanced Settings" menu when the projector detects either of the inputs mentioned above.

4. 3D support and refresh rate are as below:

- VGA/HDMI 1280 x 720, 1024 x 768, and 800 x 600 at 120 Hz
- Composite at 60 Hz

5. The recommended VGA signal for laptops is Single-mode output (Dual mode is not recommended).

6. HDMI 1.4a 3D support rates:

- 1280 x 720p @ 50 Hz Frame Packing
- 1280 x 720p @ 59.94/60 Hz Frame Packing



- 1920 x 1080p @ 23.98/24 Hz Frame Packing
- 1920 x 1080i @ 50 Hz Side by Side Half
- 1280 x 720p @ 50 Hz Top and Bottom
- 1280 x 720p @ 59.94/60 Hz Top and Bottom
- 1920 x 1080p @ 23.98/24 Hz Top and Bottom

3D FORMAT: Allows you to select the 3D format when the 3D display function is activated. Options are: Side By Side, Side By Side Full, Frame Sequential, Field Sequential, Top/Bottom, and Frame Packing.

3D SYNC INVERT: If you see a discrete or overlapping image while wearing DLP 3D goggles, you may need to execute 'Invert' to get best match of left/right image sequence to get the correct image. (For DLP 3D goggles)

PROJECTOR SETTINGS

Select and press  to activate projector settings.

The projector settings menu provides the following options:

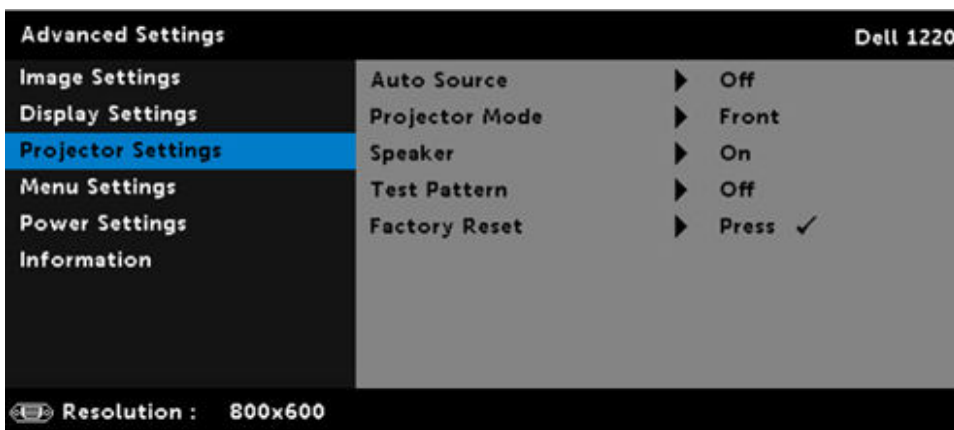

Auto Source: Select **Off** (the default) to lock the current input signal. If you press the **Source** button when the **Auto Source** mode is set to **Off**, you can manually select the input signal. Select **On** to auto detect the available input signals. If you press the **Source** button when the projector is on, it automatically finds the next available input signal.

PROJECTOR MODE: Allows you to select the projector mode, depending upon how the projector is mounted.

Rear Projection-Desktop: The projector reverses the image so that you can project from behind a translucent screen.

Rear Projection-Ceiling Mount: The projector reverses and turns the image upside down. You can project from behind a translucent screen with a ceiling-mounted projection.

Front Projection-Desktop: This is the default option.

Front Projection-Ceiling Mount: The projector turns the image upside down for ceiling-mounted projection.

SPEAKER: Select **On** to enable the speaker. Select **Off** to disable the speaker.

TEST PATTERN: Test Pattern is used to test focus and resolution. You can enable or disable the Test Pattern by selecting **Off**, **Test Pattern 1**, or **Test Pattern 2**.

Test Pattern 1:

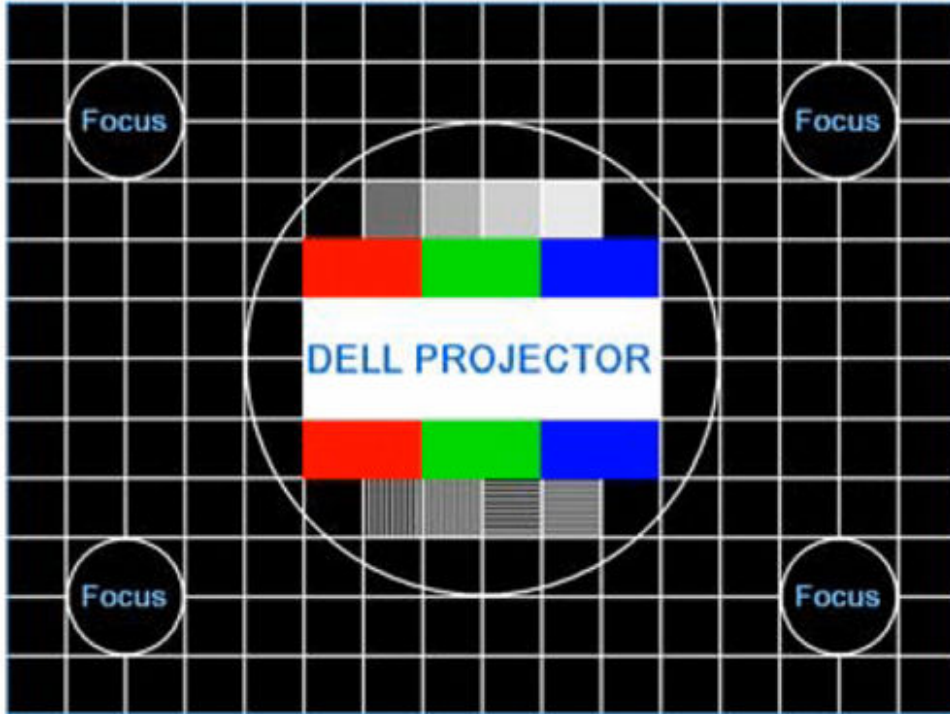

Test Pattern 2:



Factory Reset: Select Confirm and press  to reset all settings to its factory default. The below warning message appears:

Resetting to factory default

Reset items include both computer sources and Video source settings.

Menu Settings

Select and press  to activate menu settings. The menu settings consist of the following options:

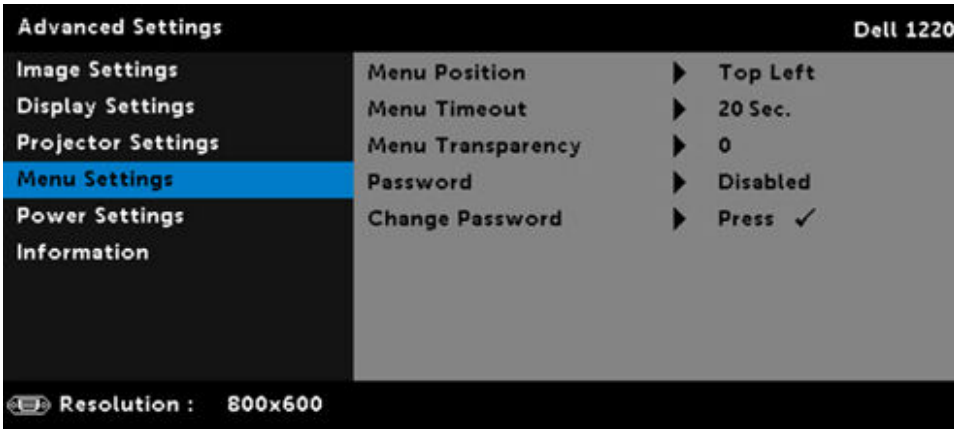

Menu Position: Allows you to change the position of the OSD menu on the screen.

Menu Timeout: Allows you to adjust the time for an OSD timeout. By default, the OSD disappears after 20 seconds of non-activity.

MENU TRANSPARENCY: Select to change the transparency level of the OSD background.

PASSWORD: When Password Protect is enabled, a Password Protect screen requesting you to enter a password will be displayed when the power plug is inserted into the electrical output and the power for the projector is first turned on. By default, this function is disabled. You can enable this feature by selecting **Enabled**. If the password has been set before, key in the password first and select the function. This password security feature will be activated the next time you turn on the projector. If you enable this feature, you will be asked to enter the projector's password after you turn on the projector:

- 1 First time password input request:
 - a Go to Menu Settings, press  and then select **Password** to enable the password settings.
- 2 If you have entered an incorrect password, you will be given two more chances. After three invalid attempts, the projector will automatically turn off.

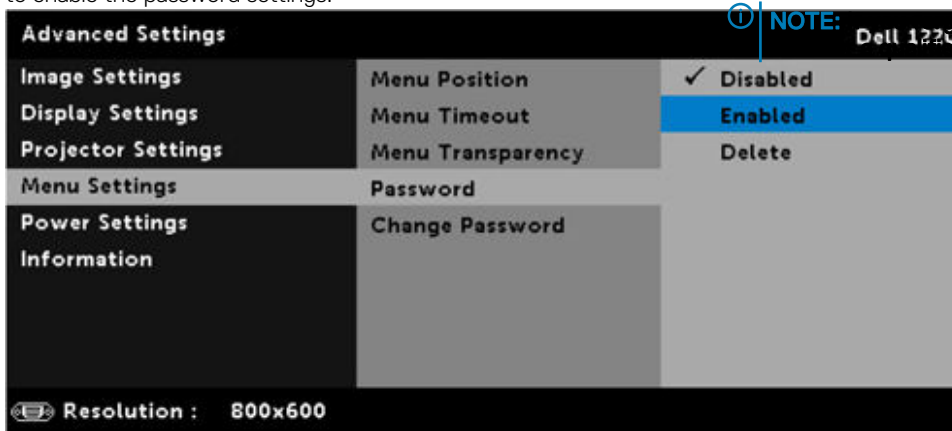

- a Enabling the Password function will pop up a change screen. Key in a 4-digit number from the screen and press

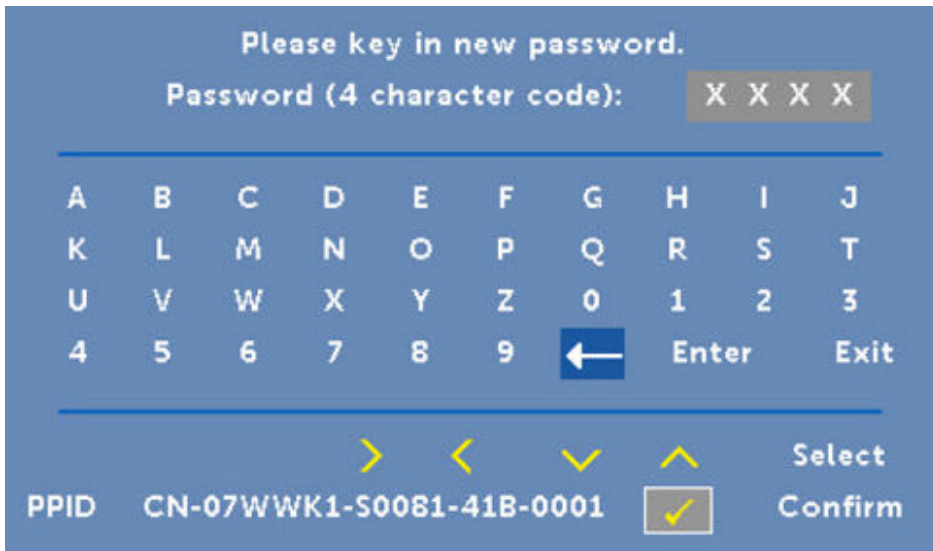

- c To confirm, enter the password again.
 - d If the password verification is successful, you may resume with accessing the projector's functions and its utilities.
- 3 To disable the password function, select the Disabled option to close the function. 4 To delete the password, select the **Delete** option.

Change Password: Key in the original password. Then, enter the new password and confirm the new password again.

POWER SETTINGS

Select and press  to activate power settings. The power settings menu provides the following options:

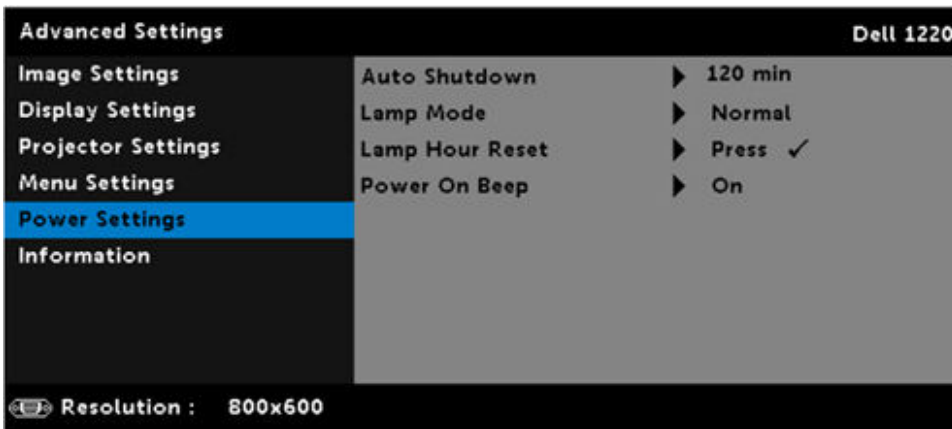

AUTO SHUTDOWN: By default, the projector is set to enter auto shutdown mode after 120 minutes of no activity. A warning message appears on screen showing a 60 seconds countdown before switching to auto shutdown mode. Press any button during the countdown period to stop the auto shutdown mode. You can also set a different delay period to enter auto shutdown mode. The delay period is the time you want the projector to wait without an input signal.

You can also set a different delay period to enter auto shutdown mode. The delay period is the time you want the projector to wait without an input signal.

If an input signal is not detected during the delay period, the projector turns off. To turn on the projector press the Power button.

Lamp Mode: Allows you to select the **Normal** or **ECO** mode.



Normal mode operates at full power level. ECO mode operates at a lower power level which may provide longer lamp life, quieter operation, and dimmer luminance output on the screen.

Lamp Hour Reset: Press  and select the Confirm option to reset the lamp hours.

Power on Beep: Select On to enable the power on beep. Select Silent to disable the power on beep.

Information

The information menu displays the current projector settings.

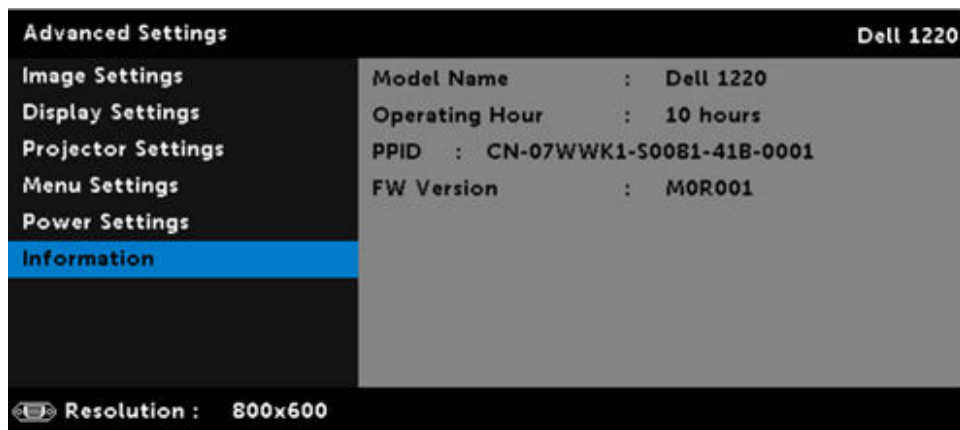

Language

Allows you to set the language for the On Screen Display (OSD). Press the Enter key on the remote control to activate the Language menu.



NOTE: Projector model shown is for representational purpose only.

Help

If you encounter problems with your projector, you can access the help menu for troubleshooting.

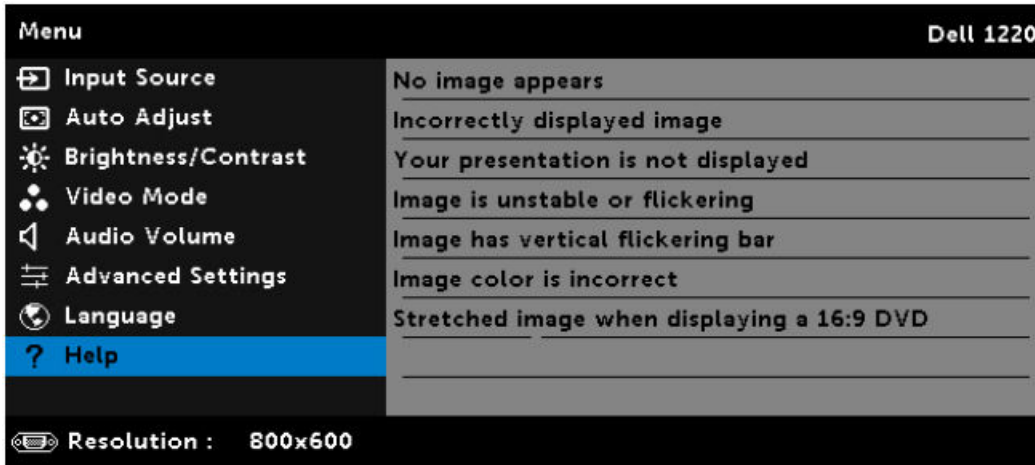

NOTE: Projector model shown is for representational purpose only.

Changing the Lamp

⚠ CAUTION: Before you begin any of the procedures in this section, follow the Safety Instructions as described in [About Your Dell Projector](#).

Replace the lamp when the message "Lamp is approaching the end of its useful life in the operation. Replacement suggested!" www.dell.com/lamps appears on the screen. If this problem persists after replacing the lamp, contact Dell. For more information, see [Getting help](#).

⚠ CAUTION: Use an original lamp to ensure safe and optimal working condition of your projector.

⚠ CAUTION: The lamp becomes very hot when in use. Do not attempt to replace the lamp until the projector has been allowed to cool down for at least 30 minutes.

⚠ CAUTION: Do not touch the bulb or the lamp glass at any time. Projector lamps are very fragile and may shatter if touched. The shattered glass pieces are sharp and can cause injury.

⚠ CAUTION: If the lamp shatters, remove all broken pieces from the projector and dispose or recycle according to state, local, or federal law. For more information see www.dell.com/hg

Reset the lamp usage time by selecting "Yes" for Lamp Reset in the OSD Power Settings of the Advanced Settings menu. When a new lamp module has been changed, the projector will automatically detect and reset the lamp hours.

⚠ CAUTION: Lamp Disposal (for the US only)

 LAMP(S) INSIDE THIS PRODUCT CONTAIN MERCURY AND MUST BE RECYCLED OR DISPOSED OF ACCORDING TO LOCAL, STATE, OR FEDERAL LAWS. FOR MORE INFORMATION, GO TO WWW.DELL.COM/HG OR CONTACT THE ELECTRONIC INDUSTRIES ALLIANCE AT WWW.EIAE.ORG FOR LAMP-SPECIFIC DISPOSAL INFORMATION, CHECK WWW.LAMPRECYCLE.ORG

ℹ NOTE: Refer to your projector's User Guide at www.dell.com/support for model-specific lamp replacement information

Guiding Signals

Table 3. Guiding Signals

Projector Status	Description	Power	Indicator	
Standby mode	Projector in Standby mode. Ready to power on.	White Flashing	TEMP (Amber) OFF	LAMP (Amber) OFF
Warming up mode	Projector takes some time to warm up and power on.	White	OFF	OFF
Lamp on	Projector in Normal mode, ready to display an image.	White	OFF	OFF
	<p>i NOTE: The OSD menu is not accessed.</p>			
Cooling mode	Projector is cooling to shutdown.	White	OFF	OFF
Projector overheated	Air vents might be blocked or ambient temperature may be above 35 °C. The projector automatically shuts down. Ensure that the air vents are not blocked and that the ambient temperature is within operational range. If the problem persists, contact Dell.	OFF	AMBER	OFF
Lamp driver overheated	The lamp driver is overheated. The air vents may be blocked. The projector automatically shuts down. Turn the display on again after the projector cools down. If the problem persists, contact Dell.	AMBER	AMBER	OFF
Fan breakdown	One of the fans has failed. The projector automatically shuts down.	OFF	AMBER Flashing	OFF

Projector Status	Description	Power	Indicator	
	If the problem persists, contact Dell.			
Lamp driver breakdown	The lamp driver has failed. The projector automatically shuts down. Unplug the power cord after three minutes and then turn the display on again. If this problem persists, contact Dell.	AMBER Flashing	OFF	AMBER Flashing
Color Wheel breakdown	Color wheel cannot start. The projector has failed and the projector automatically shuts down. Unplug the power cord after three minutes and then turn on the projector. If this problem persists, contact Dell.	White	AMBER Flashing	AMBER Flashing
Lamp failure	Lamp is defective. Replace the lamp.	OFF	OFF	AMBER
Fault - DC supply (+12V)	Power supply has been interrupted. The projector automatically shuts down. Unplug the power cord after three minutes and then turn on the projector. If this problem persists, contact Dell.	AMBER Flashing	AMBER	AMBER
Lamp module connection failed	Lamp module connection may be disrupted. Check the lamp module and ensure that it is properly installed. If the problem persists, contact Dell.	OFF	OFF	AMBER Flashing



Dell Web Management for Projectors

To access the Dell web management tool you need to set the IP addresses for your computer and the projector.

- 1 Press the **Info** key on the remote control to display the IP address of the projector, or by navigating to OSD Menu > **Advanced Settings > Information**. By default, the IP address is 10.0.50.100

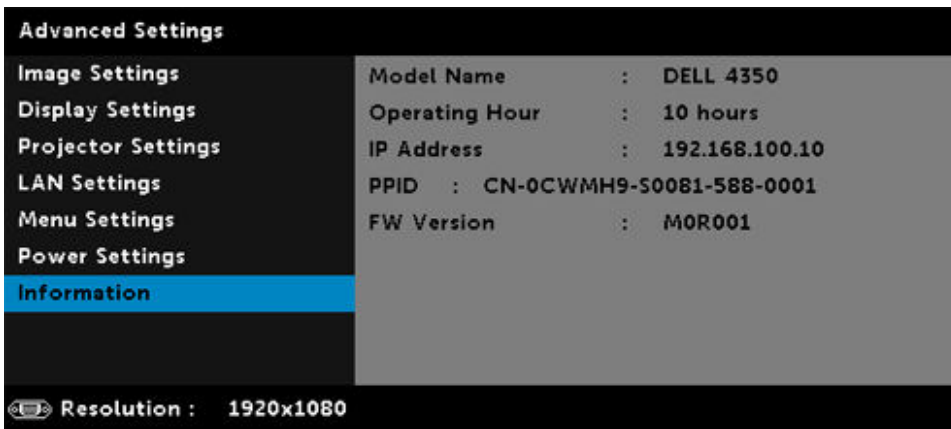

- 2 In the computer's IP Properties tab, specify an IP address by selecting **Use the following IP address** and enter the following values: For IP address: 10.0.50.101 and for Subnet Mask: 255.0.0.0 (leave all other entries as blanks).

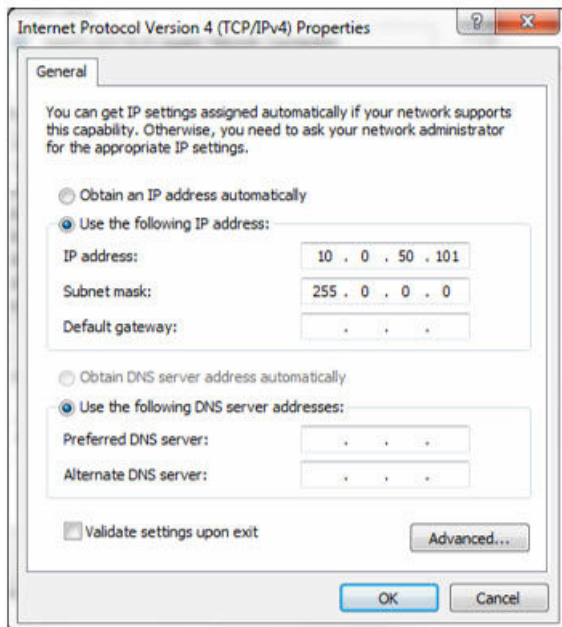

Configure notebook IP address to
10.0.50.101



Projector IP address
10.0.50.100

- 3 The IP address configuration would now look like this:

To access and use the web management tool, follow these steps:

- 1 Open a web browser and type the projector's IP address in the address bar.

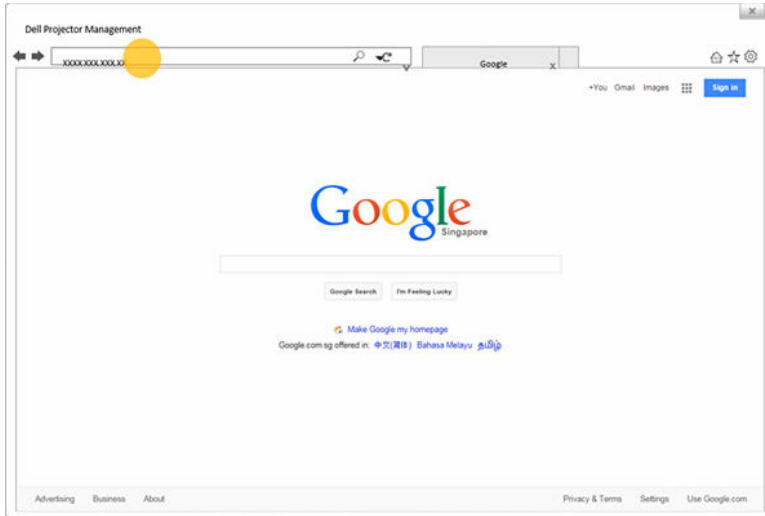

- 2 The log-in page opens. Enter the Administrator Password to continue.

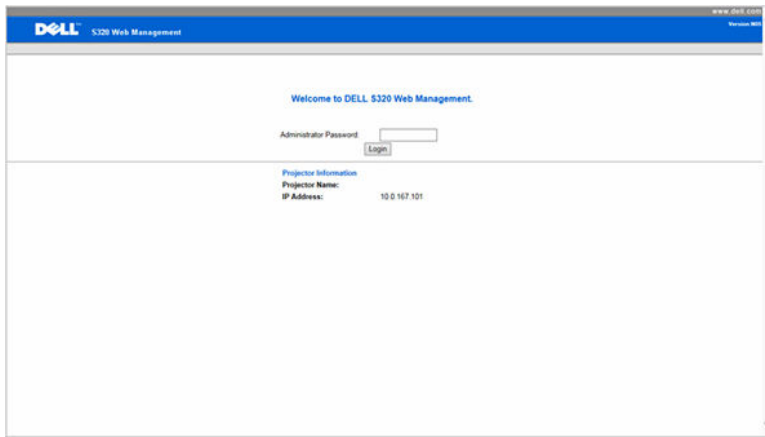

3 The Home page opens:

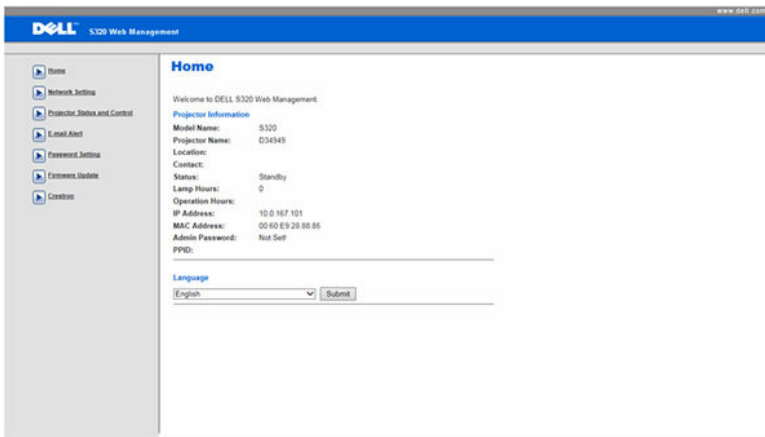

- 4 To change language, select from the drop-down list and click **Submit**.

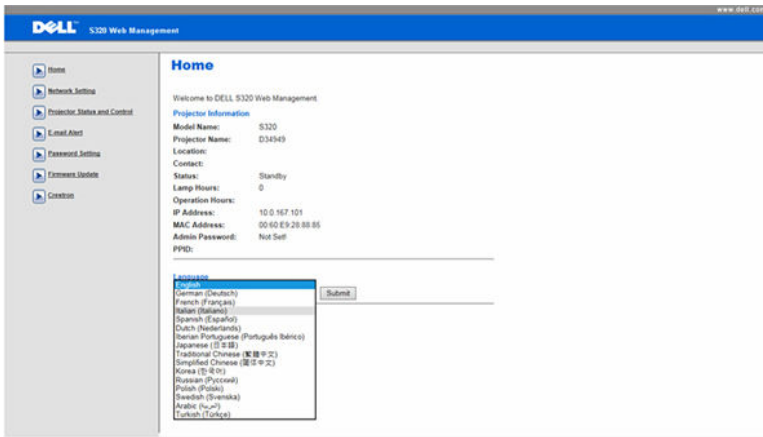

- 5 Click **Network Settings** tab to see the network settings.

The screenshot shows the Dell S320 Web Management interface. The top navigation bar includes the Dell logo, 'S320 Web Management', and the URL 'www.dell.com'. A left-hand sidebar contains a menu with the following items: Home, Network Settings (highlighted), Projector Status and Control, Local Alert, Password Settings, Firmware Update, and Creation. The main content area is titled 'Network Settings' and contains the following fields and options:

- Model Name: S320
- Projector Name: D34949
- Location: [Empty]
- Contact: [Empty]
- [Save]
- Configuration Mode: DHCP, Manual
- IP Address: 10.0.167.101
- Subnet Mask: 255.255.0.0
- Gateway: 10.0.0.254
- DNS Server: 0.0.0.0
- [Save]
- Crestron Control System Device:
 - IP Address: 255.255.255.255
 - Device ID: [Empty]
 - Port: 41794
 - [Save]

6 Click **Projector Status and Control** to see the projector's status.

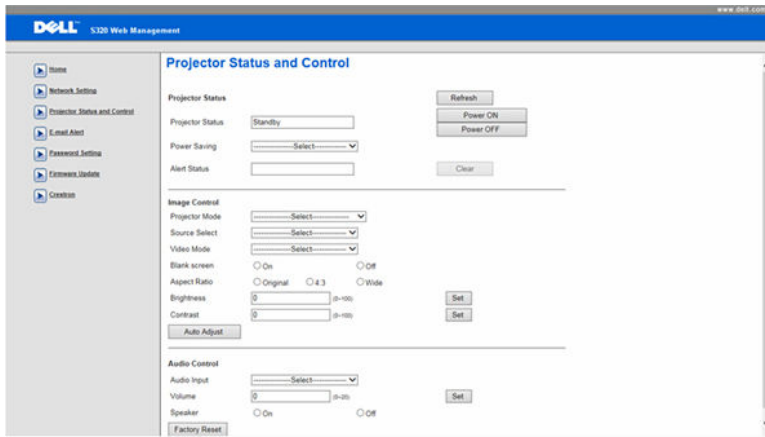

7 Select **Power Saving** frequency from the drop-down list.

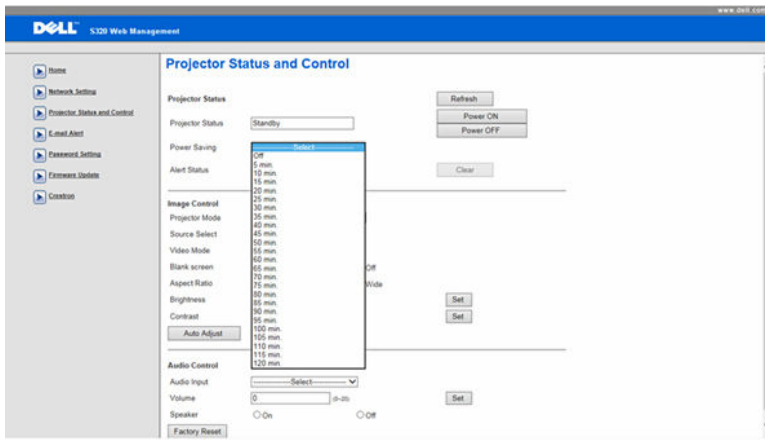

8 Select **Projector Mode**.

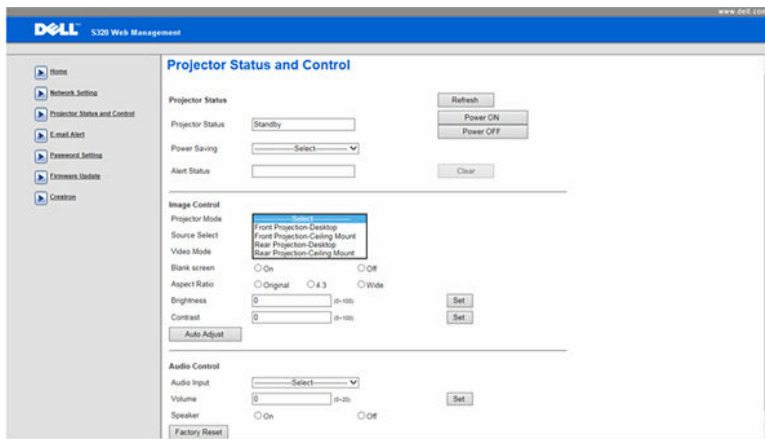

9 Select **Source**.

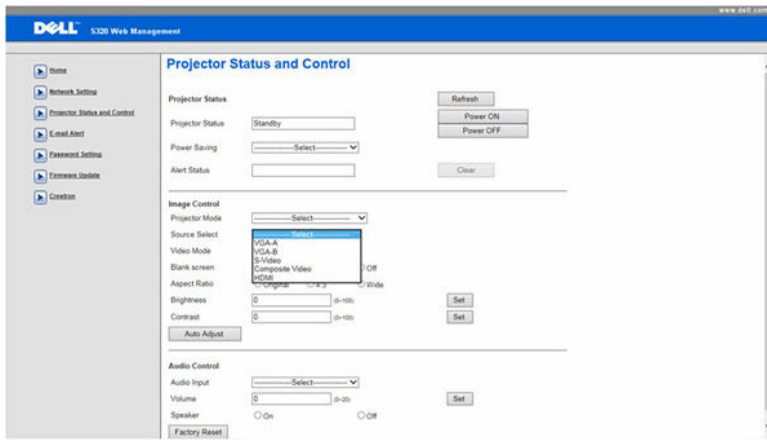

10 Select **Video Mode**.

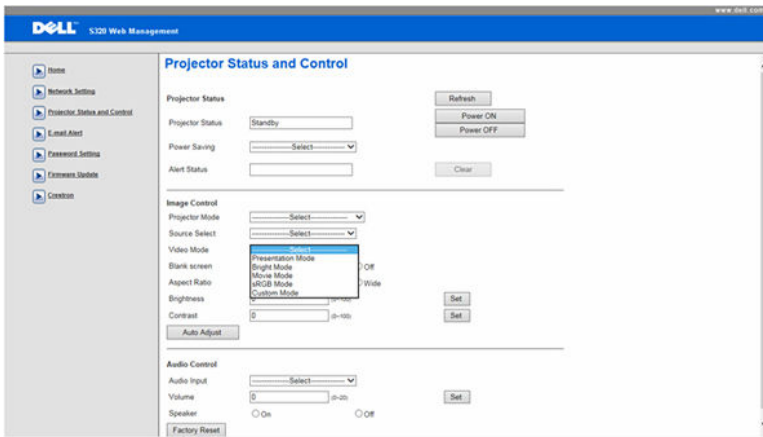

11 Select **Audio** input.

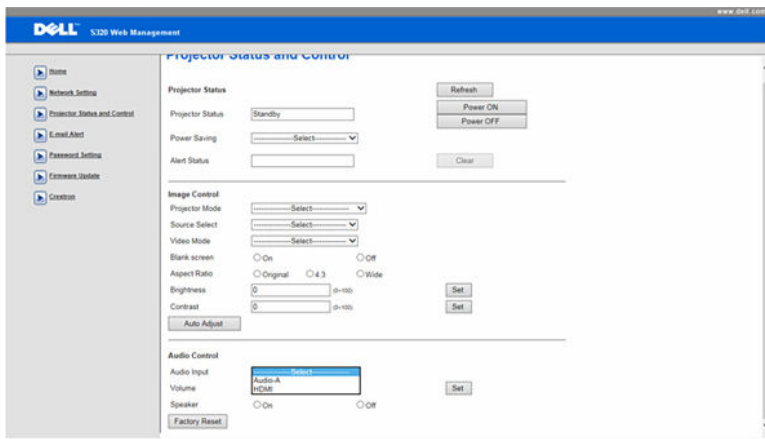

12 Set E-mail Alert.

The screenshot shows the Dell Web Management interface for configuring an E-mail Alert. The page title is "E-mail Alert". On the left, there is a navigation menu with the following items: Home, Network Settings, Processor Status and Control, Local Alert, Fan Speed Settings, Enclosure Update, and Usbport. The main content area is titled "E-mail Alert" and contains the following sections:

- E-mail Alert:** Radio buttons for "Enable" and "Disable" (selected). A button labeled "E-mail Alert Test" is located to the right.
- TO:** Text input field.
- CC:** Text input field.
- From:** Text input field.
- Subject:** Text input field with the value "3320 D34N9 Alert".
- SMTP Setting:**
 - Out going SMTP server: Text input field.
 - User name: Text input field.
 - Password: Text input field.
- Alert Condition:**
 - Lamp warning
 - Low lamp life
 - Temperature warning
- Save:** Button.

13 Set a **Password**.

The screenshot shows the Dell Web Management interface for Password Setting. The page has a blue header with the Dell logo and 'Web Management' text. A left sidebar contains navigation links: Home, Network Settings, Projector Status and Control, Email Alert, Password Settings (highlighted), Firmware Update, and Restore. The main content area is titled 'Password Setting' and includes a message: 'Please set your password if you enable this feature for first time. If password is set, you will require to enter with your password upon you connect to the Web Management.' Below this, there are two sections: 'Administrator' and 'Set Security For SNMP'. The 'Administrator' section has a 'Password' label, radio buttons for 'Enable' and 'Disable' (with 'Disable' selected), and a 'Submit' button. Below it are 'New Password' and 'Confirm Password' labels, each with a text input field and a 'Submit' button. The 'Set Security For SNMP' section has a 'Write Community' label, a text input field containing 'private', and a 'Submit' button.

14 Update **Firmware**. You can download the latest drivers from the Dell Support website at www.dell.com/support

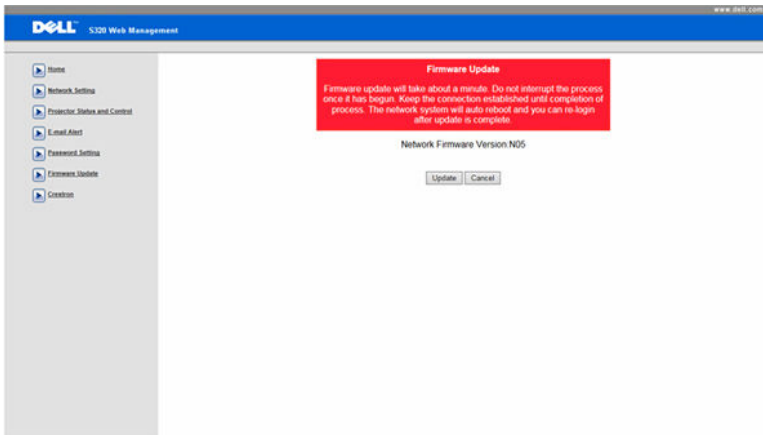

15 Access the **Crestron RoomView** application.

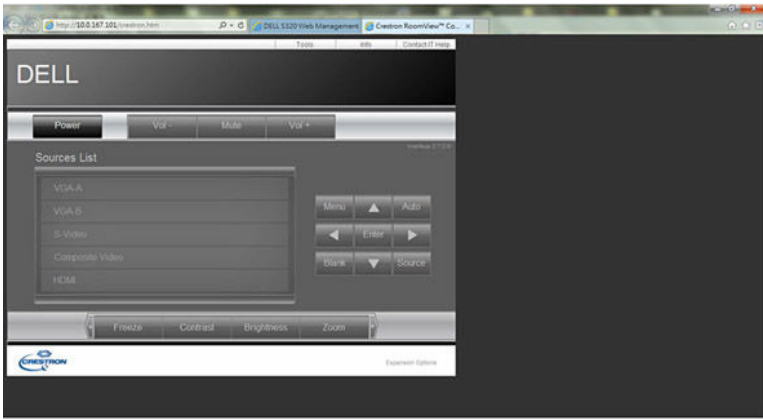

Getting help

Contacting Dell

Dell provides several online and telephone based support and service options. If you do not have an active internet connection, you can find contact information about your purchase invoice, packing slip, bill, or Dell product catalog. Availability varies by country and product, and some services may not be available in your area. To contact Dell for sales, technical assistance, or customer service issues:

- 1 Go to Dell.com/support.
- 2 Select your country from the drop-down menu on the lower right corner of the page.
- 3 For customized support:
 - a Enter your system Service Tag in the **Enter your Service Tag** field.
 - b Click **Submit**.
The support page that lists the various support categories is displayed.
- 4 For general support:
 - a Select your product category.
 - b Select your product segment.
 - c Select your product.
The support page that lists the various support categories is displayed.
- 5 For contact details of Dell Global Technical Support:
 - a Click [Global Technical Support](#).
 - b The **Contact Technical Support** page is displayed with details to call, chat, or e-mail the Dell Global Technical Support team.

Glossary

ANSI Lumens — A standard for measuring the brightness. It is calculated by dividing a square meter image into nine equal rectangles, measuring the lux (or brightness) reading at the center of each rectangle, and averaging these nine points.

Aspect Ratio — The most popular aspect ratio is 4:3 (4 by 3). Early television and computer video formats are in a 4:3 aspect ratio, which means that the width of the image is 4/3 times the height. **Brightness** — The amount of light emitted from a display or projection display or projection device. The brightness of projector is measured by ANSI lumens.

Color Temperature — The color appearance of white light. Low color temperature implies warmer (more yellow/red) light while high color temperature implies a colder (more blue) light. The standard unit for color temperature is Kelvin (K).

Component Video — A method of delivering quality video in a format that consists of the luminance signal and two separate chrominance signals and are defined as Y'Pb'Pr' for analog component and Y'Cb'Cr' for digital component. Component video is available on DVD players.

Composite Video — A video signal that combines the luma (brightness), chroma (color), burst (color reference), and sync (horizontal and vertical synchronizing signals) into a signal waveform carried on a single wire pair. There are three kinds of formats, namely, NTSC, PAL, and SECAM.

Compressed Resolution — If the input images are of higher resolution than the native resolution of the projector, the resulting image will be scaled to fit the native resolution of the projector. The nature of compression in a digital device means that some image content is lost.

Contrast Ratio — Range of light and dark values in a picture, or the ratio between their maximum and minimum values. There are two methods used by the projection industry to measure the ratio:

- 1 Full On/Off — measures the ratio of the light output of an all white image (full on) and the light output of an all black (full off) image.
- 2 ANSI — measures a pattern of 16 alternating black and white rectangles. The average light output from the white rectangles is divided by the 7 Appendix: Glossary Glossary 53 average light output of the black rectangles to determine the ANSI contrast ratio.

Full On/Off contrast is always a larger number than ANSI contrast for the same projector.

dB — decibel — A unit used to express relative difference in power or intensity, usually between two acoustic or electric signals, equal to ten times the common logarithm of the ratio of the two levels.

Diagonal Screen — A method of measuring the size of a screen or a projected image. It measures from one corner to the opposite corner. A 9 FT high, 12 FT wide, screen has a diagonal of 15 FT. This document assumes that the diagonal dimensions are for the traditional 4:3 ratio of a computer image as per the example above.

DHCP — Dynamic Host Configuration Protocol — A network protocol that enables a server to automatically assign a TCP/IP address to a device.

DLP® — Digital Light Processing™ — Reflective display technology developed by Texas Instruments, using small manipulated mirrors. Light passing through a color filter is sent to the DLP mirrors which arrange the RGB colors into a picture projected onto screen, also known as DMD.

DMD — Digital Micro-Mirror Device — Each DMD consists of thousands of tilting, microscopic aluminum alloy mirrors mounted on a hidden yoke.

Focal Length — The distance from the surface of a lens to its focal point. **Frequency** — It is the rate of repetition in cycles per seconds of electrical signals. Measured in Hz (Hertz).

HDCP — High-Bandwidth Digital-Content Protection — A specification developed by Intel™ Corporation to protect digital entertainment across digital interface, such as DVI, HDMI.



HDMI — High-Definition Multimedia Interface — HDMI carries both uncompressed high definition video along with digital audio and device control data in a single connector.

Hz (Hertz) — Unit of frequency.

Keystone Correction — Device that will correct an image of the distortion (usually a wide-top narrow-bottom effect) of a projected image caused by improper projector to screen angle.

Maximum Distance — The distance from a screen the projector can be to cast an image that is usable (bright enough) in a fully darkened room.

Maximum Image Size — The largest image a projector can throw in a darkened room. This is usually limited by focal range of the optics.

Minimum Distance — The closest position that a projector can focus an image onto a screen.

NTSC — National Television Standards Committee. North American standard for video and broadcasting, with a video format of 525 lines at 30 frames per second.

PAL — Phase Alternating Line. A European broadcast standard for video and broadcasting, with a video format of 625 lines at 25 frames per second.

Reverse Image — Feature that allows you to flip the image horizontally. When used in a normal forward projection environment text, graphics, etc. are backwards. Reverse image is used for rear projection.

RGB — Red, Green, Blue — typically used to describe a monitor that requires separate signals for each of the three colors.

SECAM — A French and international broadcast standard for video and broadcasting, closely related to PAL but with a different method of sending color information.

SVGA — Super Video Graphics Array — 800 x 600 pixels count.

SXGA — Super Extended Graphics Array, — 1280 x 1024 pixels count.

UXGA — Ultra Extended Graphics Array — 1600 x 1200 pixels count.

VGA — Video Graphics Array — 640 x 480 pixels count.

WEP — Wired Equivalent Privacy — This is a method for encrypting communication data. The encryption key is created and notified only to the communicating user, so the communication data cannot be decrypted by a third party.

XGA — Extended Video Graphics Array — 1024 x 768 pixels count.

WXGA — Wide Extended Graphics Array — 1280 x 800 pixels count.